

tivoli®

TRACE

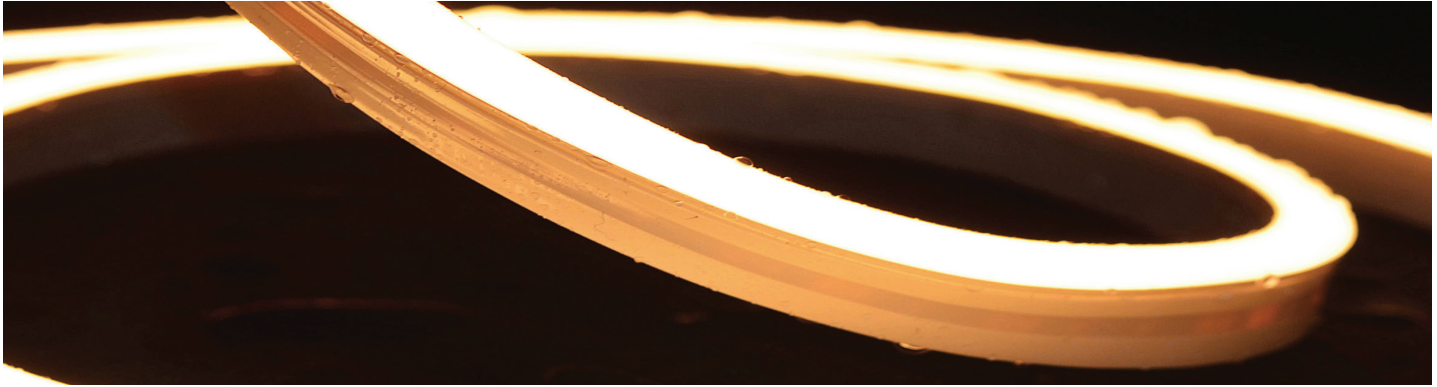

HORIZONTAL



Project: _____ Type: _____

Product Features

- Constructed using flexible SMD LEDs with zero voltage drop for reliability and uniformity of light
- Used to outline structures or where traditional glass neon is used
- Low Voltage 24V DC
- Long-life LEDs with tight cutting increments for precise field installation
- UV Stabilized for exterior use with silicone housing (no yellowing or cracking)
- IP67 Rating
- IK07 Rating - protected against 2 joules impact
- 1 Bin, 1.5 step color consistency



Dimensions

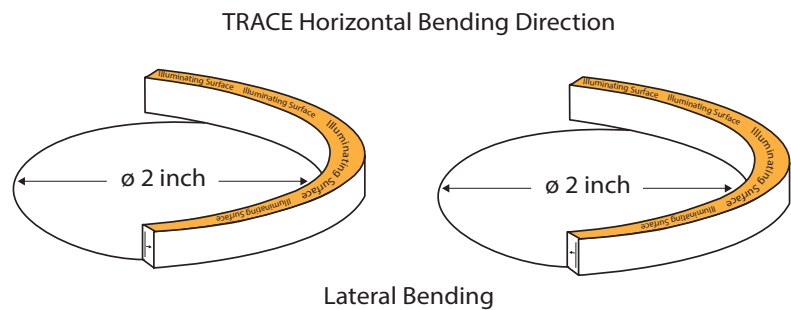
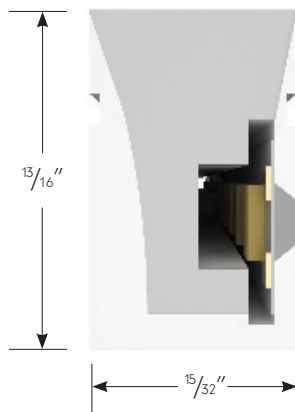

Order Specification Guide

NOTE: Lengths and quantity of each run must be submitted at time of order.
 TRACE is factory prep only. In-field cutting will void warranty.

PRODUCT CODE	INTENSITY	PROFILE	LED COLOR	VOLTAGE
TRCE		H		24
TRCE = Trace Flexible Light	L = Low Output S = Standard Output H = High Output	H = Horizontal	24 = 2400K 27 = 2700K 30 = 3000K 35 = 3500K* 40 = 4000K 50 = 5000K* GR = Green* BL = Blue RD = Red AM = Amber*	24 = 24V DC

*Special Order Option. Consult factory for lead time and MOQ.

Specifications

Output (2700K)			
LED Intensity	Low Output	Standard Output	High Output
Lumens (lm/ft)	48	96	144
Beam Angle	124.4°		
Efficacy (lm/W)	32		
LEDs	2835		
CRI	>80		
Electrical			
Dimming	TRIAC, ELV, MLV, 0-10V, DMX		
Input Voltage	24V DC		
Power Consumption (W/ft)	1.5	3	4.5
Maximum Run	58'	29'	19'
Physical			
Dimensions	15/32" X 13/16"		
Cutting Increments	1.97"		
Material	UV, Solvent, Saltwater resistant silicone		
Wire Exit Options	Front, Side, Bottom		
LED PIN Temperature	65°C / 149°F		
Storage Temperature	-25°C / -13°F - 60°C / 140°F		
Ambient Temperature	Ta _{min} = 33°C / 90°F, Ta _{max}		
Certification and Testing			
Certification	UL		
Environment	Wet Location		
IP Rating	IP67		
IK Rating	IK07		
Warranty	3 Years		

- Maximum Run length refers to single side feed in serial connection
- The given color temperature is the strip (after coating) color temperature
- The given data are typical values due to the tolerances of the production process and electrical components; values for the light output and electrical power can vary up to 10%

Photometrics

TRACE Horizontal: Based on 2700K

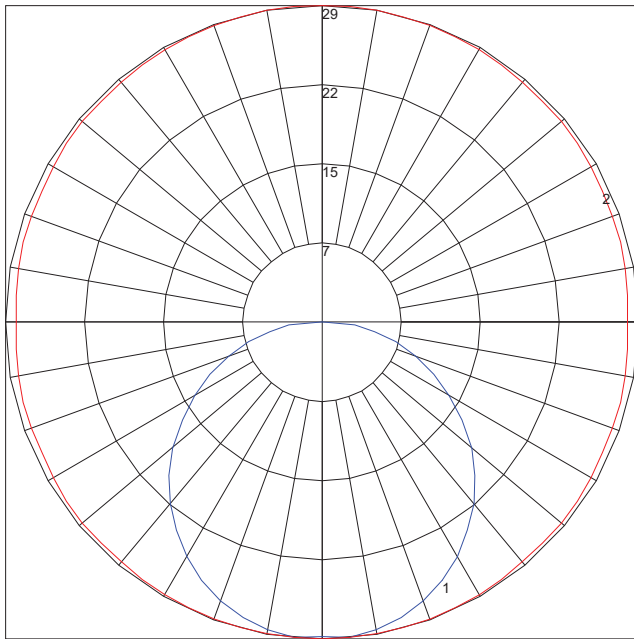

Maximum Candela = 29.44
 Located At Horizontal Angle = 85
 Vertical Angle = 5
 #1 Vertical Plane Through Horizontal Angles (85-265) (Through Max. Cd.)
 #2 Vertical Cone Through Vertical Angle (5) (Through Max. Cd.)

TM-30

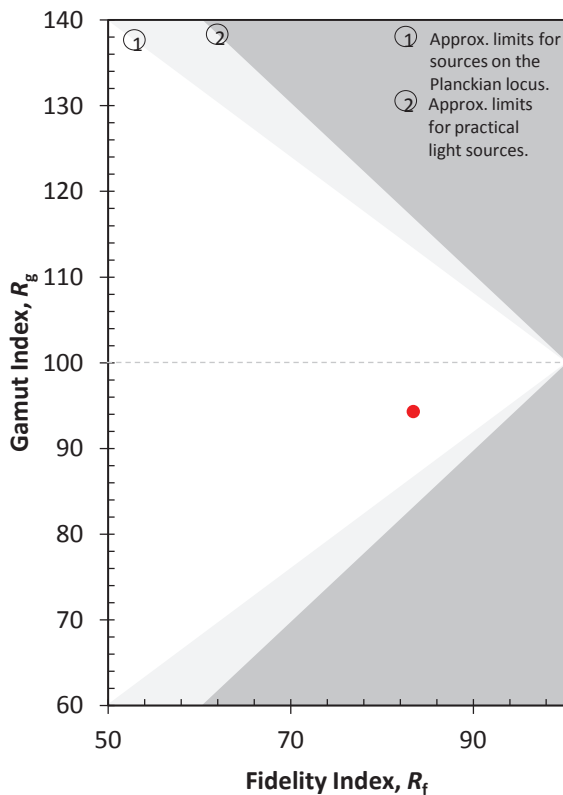

Hue Bin	R_f	Graphic shifts (%)	
		Chroma	Hue
1	78	-11%	1%
2	81	-7%	6%
3	80	-4%	9%
4	89	-3%	3%
5	93	-1%	3%
6	95	0%	0%
7	89	-5%	-3%
8	91	-5%	2%
9	84	-5%	6%
10	79	-3%	12%
11	81	2%	13%
12	84	7%	1%
13	85	3%	-9%
14	78	4%	-16%
15	83	-5%	-7%
16	74	-9%	-15%

TM-30

TRACE Horizontal: Based on 2700K

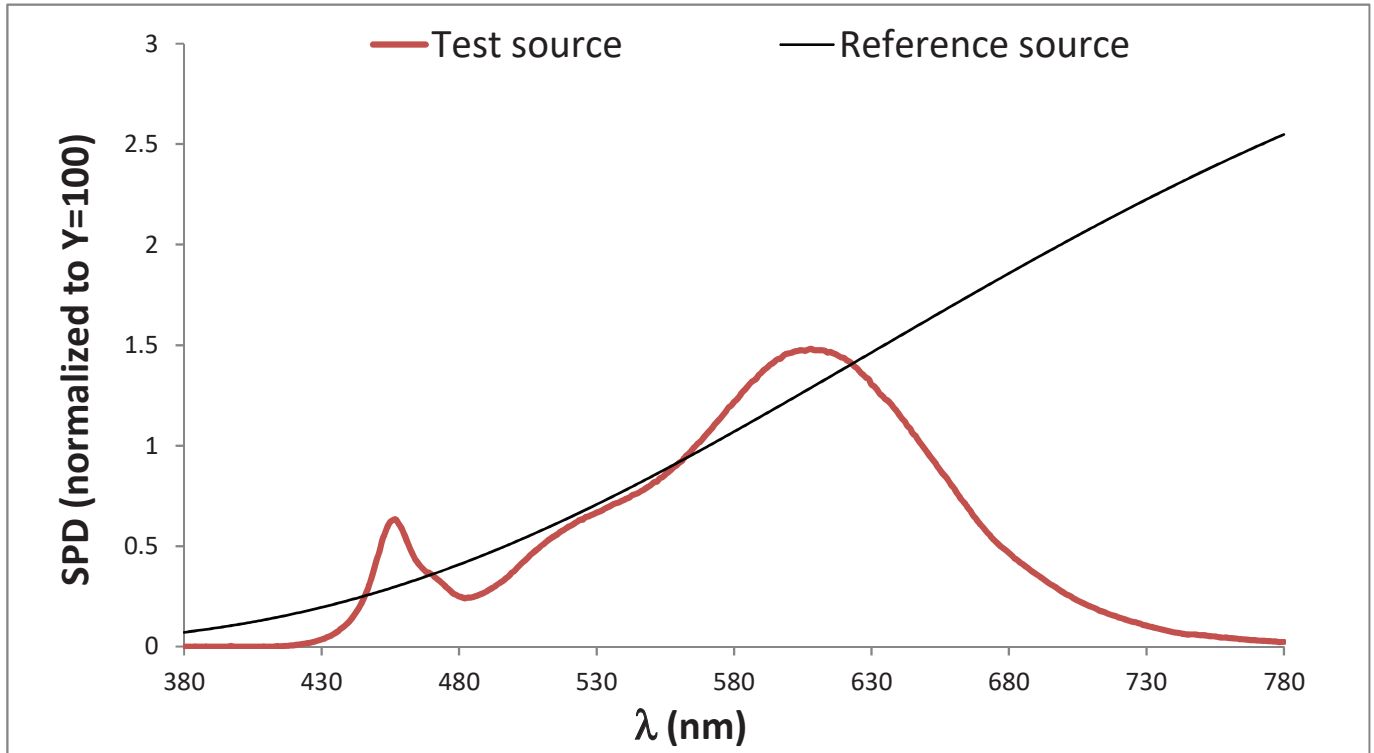

Color Vector Graphic

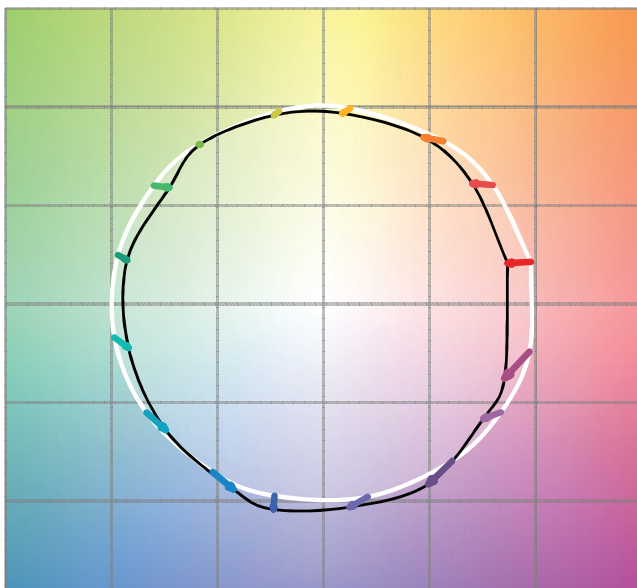

Color Distortion Graphic

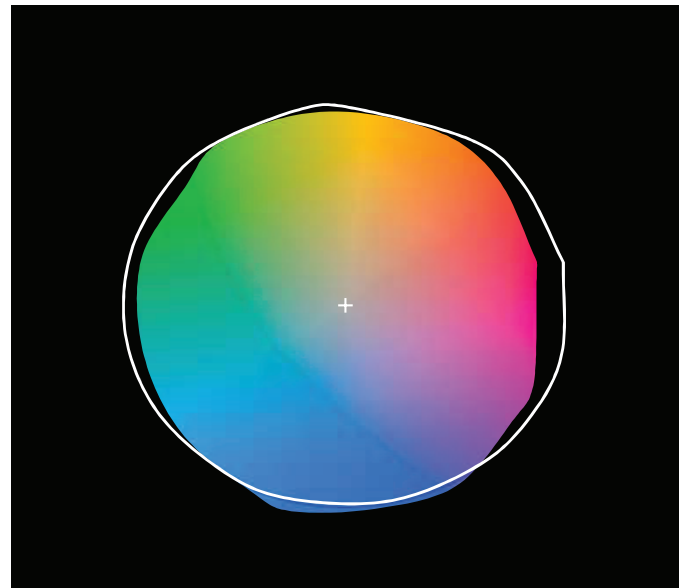

Hue Angle Bin vs. Fidelity Index

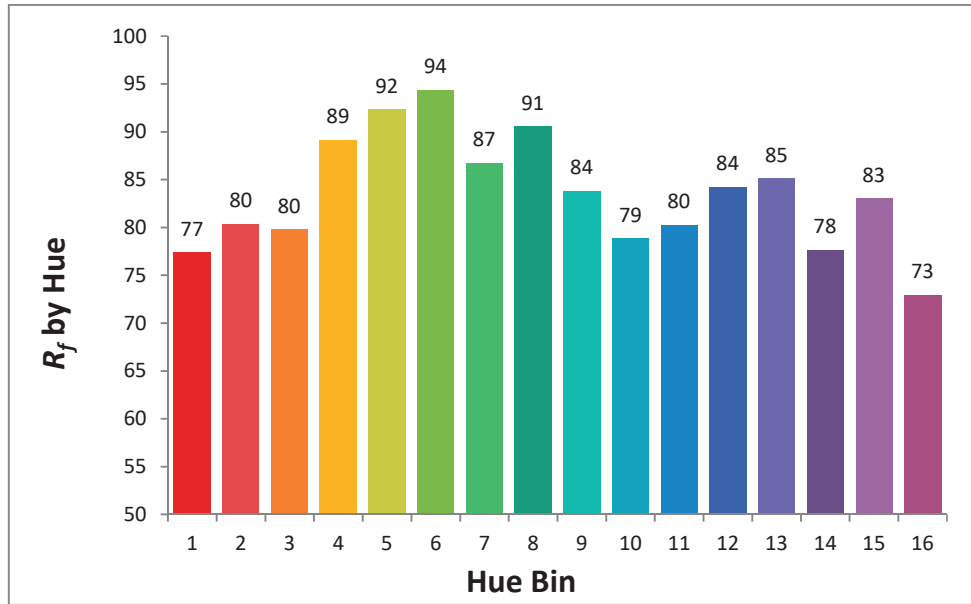

Hue Angle Bin vs. Change of Chroma

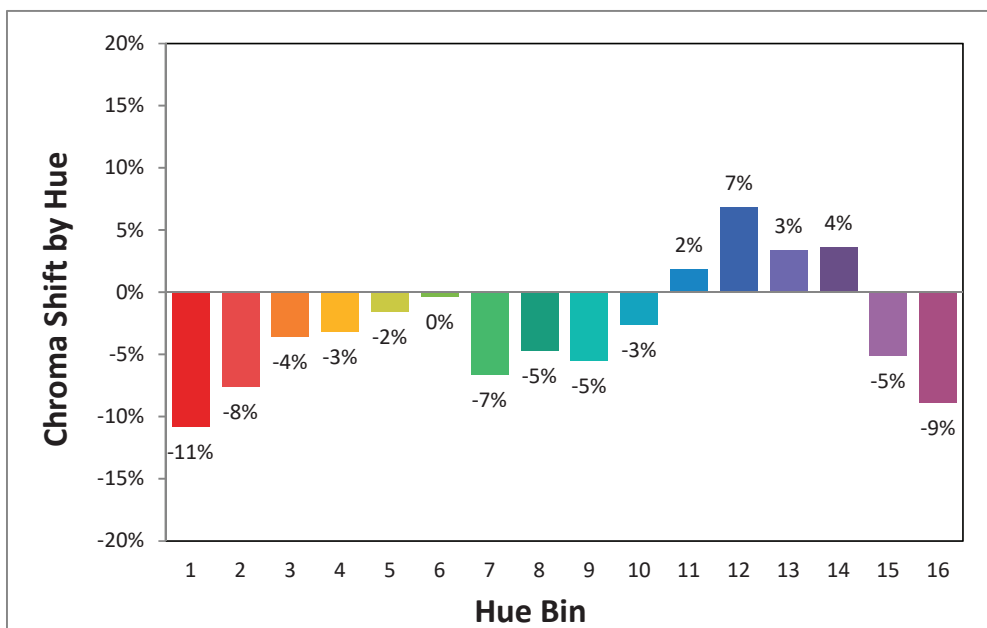

Power Lead Options - Horizontal

IP67: Rated for outdoor use and factory assembled.
 Note: The end cap is made of UV stabilized polycarbonate, which produces no yellowing and cracking over time.

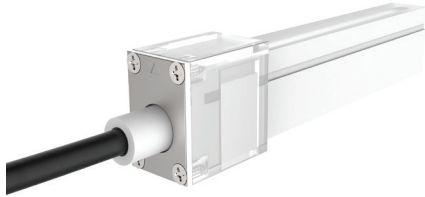

TRACE LEAD - FRONT
 Horizontal Front Lead Entry
 5' Power Lead Cable with End Cap

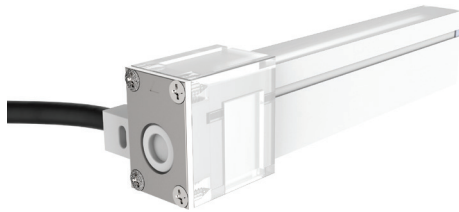
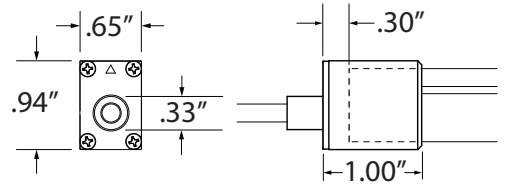

TRACE LEAD - SIDE
 Horizontal Side Lead Entry
 5' Power Lead Cable with End Cap

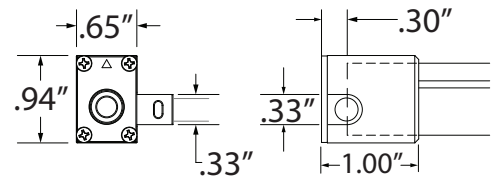

TRACE LEAD - BOTTOM
 Horizontal Bottom Lead Entry
 5' Power Lead Cable with End Cap

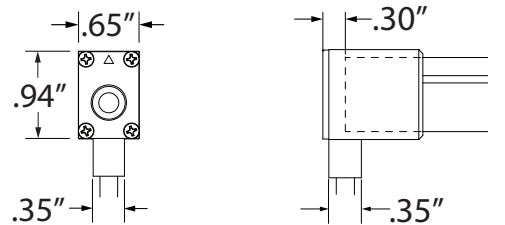

TRACE END CAP
 Horizontal End Cap (No Lead)
 1 pc End Cap with 4 Screws

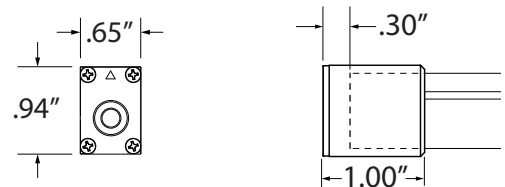

Power Leads - How to Configure

It is important to note the orientation of TRACE and what is considered Left Facing and Right Facing. TRACE is polarity specific and proper submission of power leads for each run is necessary for factory prep standards.

HORIZONTAL TRACE - The cut window will always indicate as Back (Image A).

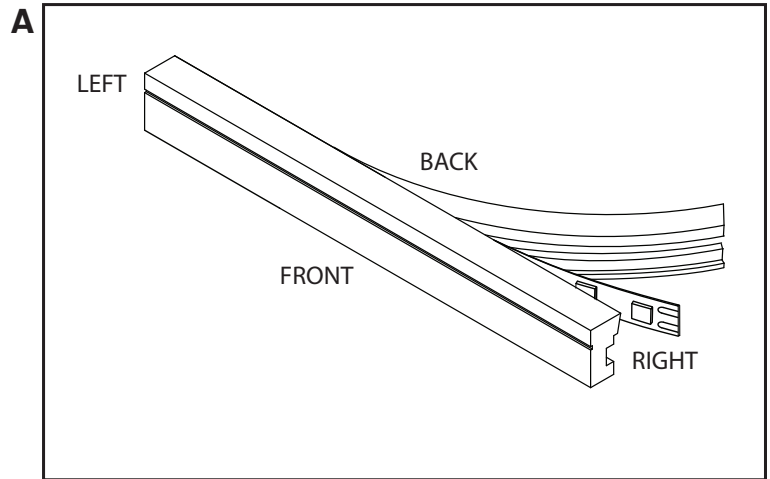

Power Lead Configurations

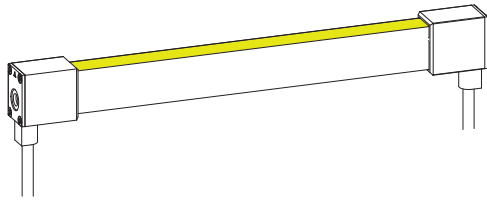

TRCE-H-LEAD-B-B

Left Facing Bottom Lead with 5' Power Cable to
Right Facing Bottom Lead with 5' Power Cable

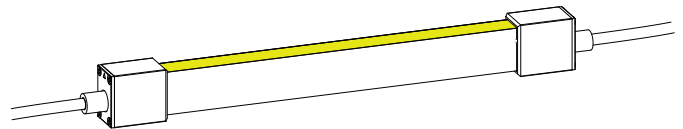

TRCE-H-LEAD-F-F

Left Facing Front Lead with 5' Power Cable to
Right Facing Front Lead with 5' Power Cable

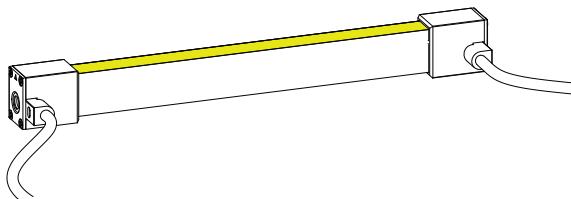

TRCE-H-LEAD-S-S

Left Facing Side Lead with 5' Power Cable to
Right Facing Side Lead with 5' Power Cable

Power Lead Configurations

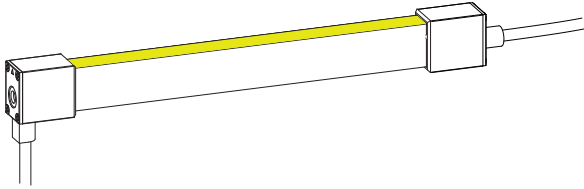

TRCE-H-LEAD-B-F

Left Facing Bottom Lead with 5' Power Cable to
Right Facing Front Lead with 5' Power Cable

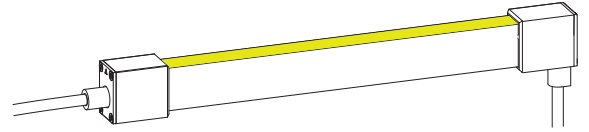

TRCE-H-LEAD-F-B

Left Facing Front Lead with 5' Power Cable to
Right Facing Bottom Lead with 5' Power Cable

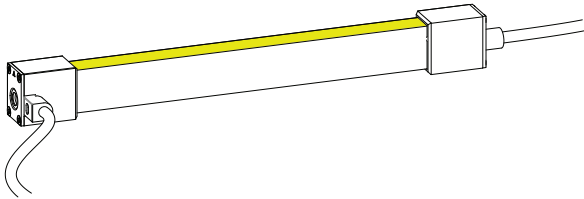

TRCE-H-LEAD-S-F

Left Facing Side Lead with 5' Power Cable to
Right Facing Front Lead with 5' Power Cable

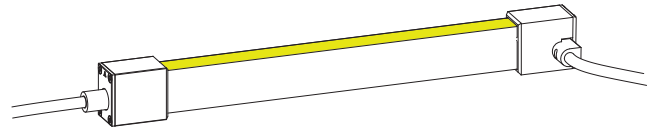

TRCE-H-LEAD-F-S

Left Facing Front Lead with 5' Power Cable to
Right Facing Side Lead with 5' Power Cable

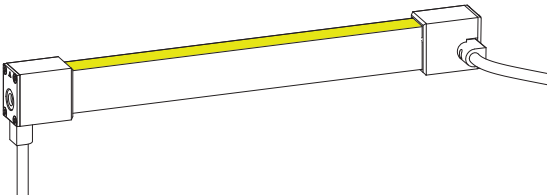

TRCE-H-LEAD-B-S

Left Facing Bottom Lead with 5' Power Cable to
Right Facing Side Lead with 5' Power Cable

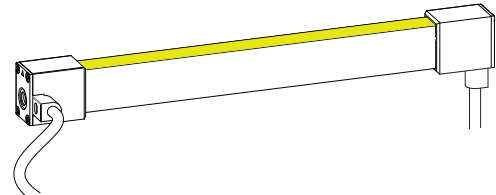

TRCE-H-LEAD-S-B

Left Facing Side Lead with 5' Power Cable to
Right Facing Bottom Lead with 5' Power Cable

Power Lead Configurations

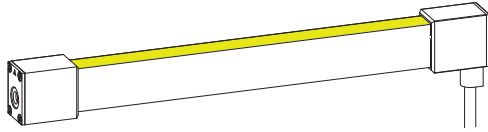

TRCE-H-LEAD-E-B
Left End Cap Lead to Right Facing Bottom Lead with 5' Power Cable

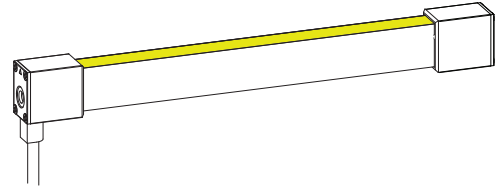

TRCE-H-LEAD-B-E
Left Facing Bottom Lead with 5' Power Cable to Right End Cap

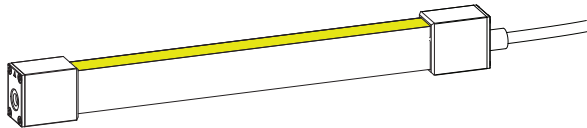

TRCE-H-LEAD-E-F
Left End Cap Lead to Right Facing Front Lead with 5' Power Cable

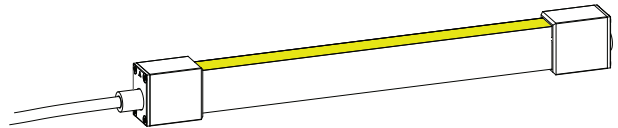

TRCE-H-LEAD-F-E
Left Facing Front Lead with 5' Power Cable to Right End Cap

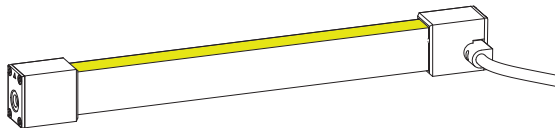

TRCE-H-LEAD-E-S
Left Facing End Cap Lead to Right Facing Side Lead with 5' Power Cable

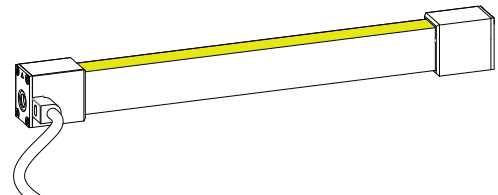

TRCE-H-LEAD-S-E
Left Facing Side Lead with 5' Power Cable to Right Facing End Cap

Mounting Options

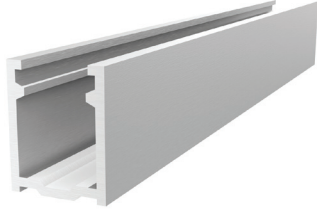

TRCE-H-SLV-SCHAN-6.5

Straight Channel
Horizontal Profile Only
6.56' Length, Aluminum

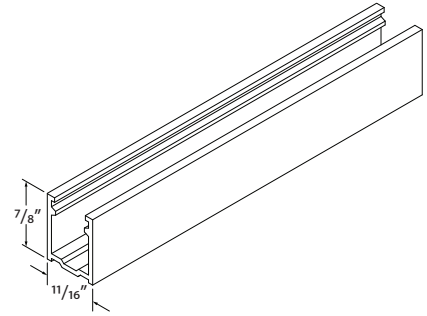

TRCE-H-SLV-NCHAN-6.5

Notched Channel
Horizontal Profile Only
Radius Bend: 11"
6.56' Length, Aluminum

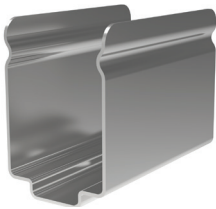
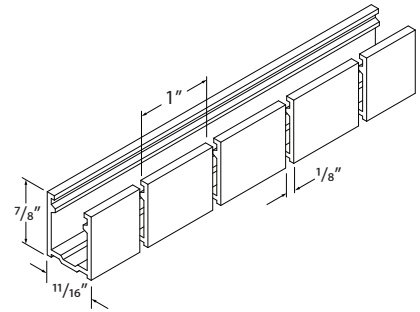

TRCE-H-SLS-MTCLIPS

Mounting Clips
Horizontal Profile Only
2 Stainless Steel Clips with 2 Screws

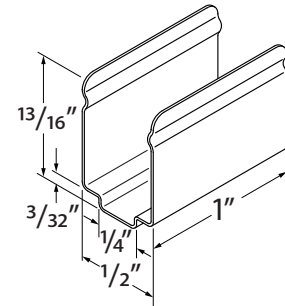

FLXD-SIL-GE-10

GE Silicone 10oz Tube
Use to adhere TRACE into entire run length of channel
25' estimated bead length per 10oz tube

Controls & Software

CONTROLS



TVOQ-10-XX-7
 XX = BK (black), WH (white)
 1024 DMX channel, 500 scene,
 10 zone, glass touch screen

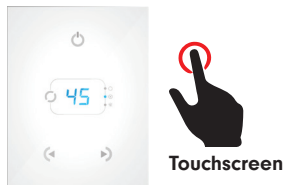

TVOQ-2-XX
 XX = BK (black), WH (white)
 512 DMX channel, 99 scene,
 1 zone, glass touch screen



TVOQ-1-WHT
 512 DMX channel, 16 scene,
 4 zone, glass touch screen

SOFTWARE



Cue™ and CuePro™ softwares are specifically designed for the TivoCUE™ in-wall DMX controls and includes an array of tools required by the latest DMX lighting fixtures. Intuitive, with easy-to-use effects that can be dropped into timelines, and multi-zone synchronization capabilities allow you to program a project effortlessly.



Power Supplies - Indoor

ADUL - NON DIMMING

DESCRIPTION	CAT NO	APPLICATION	PRIMARY VOLTAGE	SECONDARY VOLTAGE	CIRCUIT BREAKERS	MAX LOAD	CIRCUIT CAPACITY
ADUL Series Class 2 Transformer	ADUL-120-1-4-24-D	Indoor / Damp	100-277V AC 5ø60 HZ	24V DC	1	96W	4A
	ADUL-240-2-4-24-D				2	2x96W	2x4A
	ADUL-320-3-4-24-D				3	3x96W	3x4A

ADUL - 0-10V DIMMING

DESCRIPTION	CAT NO	APPLICATION	PRIMARY VOLTAGE	SECONDARY VOLTAGE	CIRCUIT BREAKERS	MAX LOAD	CIRCUIT CAPACITY
ADUL Series Class 2 Transformer	ADUL-120-1-4-24-DOT	Indoor / Damp	100-277V AC 5ø60 HZ	24V DC	1	96W	4A
	ADUL-240-2-4-24-DOT				2	2x96W	2x4A
	ADUL-320-3-4-24-DOT				3	3x96W	3x4A

ADUL - DMX SINGLE ADDRESS

DESCRIPTION	CAT NO	APPLICATION	PRIMARY VOLTAGE	SECONDARY VOLTAGE	CIRCUIT BREAKERS	MAX LOAD	CIRCUIT CAPACITY
ADUL Series Class 2 Transformer	ADUL-120-1-4-24-DIN	Indoor / Damp	100-277V AC 5ø60 Hz	24V DC	1	96W	4A
	ADUL-240-2-4-24-DIN				2	2x96W	2x4A
	ADUL-320-3-4-24-DIN				3	3x96W	3x4A

ADUL - DMX MULTI ADDRESS

DESCRIPTION	CAT NO	APPLICATION	PRIMARY VOLTAGE	SECONDARY VOLTAGE	CIRCUIT BREAKERS	MAX LOAD	CIRCUIT CAPACITY
ADUL Series Class 2 Transformer	ADUL-240-2-4-24-DIN-2	Indoor / Damp	100-277V AC 5ø60 Hz	24V DC	2	2x96W	2x4A
	ADUL-320-3-4-24-DIN-3				3	3x96W	3x4A

Power Supplies - Outdoor
ADNM - NON DIMMING

DESCRIPTION	CAT NO	APPLICATION	PRIMARY VOLTAGE	SECONDARY VOLTAGE	CIRCUIT BREAKERS	MAX LOAD	CIRCUIT CAPACITY
ADNM Series Class 2 Transformer	ADNM-90-1-4-24-D	Indoor / Outdoor	100-277V AC 5ø60 Hz	24V DC	1	90W	3.75A
	ADNM-120-1-4-24-D				1	96W	4A
	ADNM-240-2-4-24-D				2	2x96W	2x4A
	ADNM-320-3-4-24-D				3	3x96W	3x4A

ADNM - 0-10V DIMMING

DESCRIPTION	CAT NO	APPLICATION	PRIMARY VOLTAGE	SECONDARY VOLTAGE	CIRCUIT BREAKERS	MAX LOAD	CIRCUIT CAPACITY
ADNM Series Class 2 Transformer	ADNM-90-1-4-24-DOT	Indoor / Outdoor	100-277V AC 5ø60 Hz	24V DC	1	90W	3.75A
	ADNM-120-1-4-24-DOT				1	96W	4A
	ADNM-240-2-4-24-DOT				2	2x96W	2x4A
	ADNM-320-3-4-24-DOT				3	3x96W	3x4A

ADNM - DMX SINGLE ADDRESS

DESCRIPTION	CAT NO	APPLICATION	PRIMARY VOLTAGE	SECONDARY VOLTAGE	CIRCUIT BREAKERS	MAX LOAD	CIRCUIT CAPACITY
ADNM Series Class 2 Transformer	ADNM-90-1-4-24-DIN	Indoor / Outdoor	100-277V AC 5ø60 Hz	24V DC	1	90W	3.75A
	ADNM-120-1-4-24-DIN				1	96W	4A
	ADNM-240-2-4-24-DIN				2	2x96W	2x4A
	ADNM-320-3-4-24-DIN				3	3x96W	3x4A

ADNM - DMX MULTI ADDRESS

DESCRIPTION	CAT NO	APPLICATION	PRIMARY VOLTAGE	SECONDARY VOLTAGE	CIRCUIT BREAKERS	MAX LOAD	CIRCUIT CAPACITY
ADNM Series Class 2 Transformer	ADNM-240-2-4-24-DIN-2	Indoor / Outdoor	100-277V AC 5ø60 Hz	24V DC	2	2x96W	2x4A
	ADNM-320-3-4-24-DIN-3				3	3x96W	3x4A

ADNM - DMX/DALI FLICKER-FREE FOR TV STUDIO

DESCRIPTION	CAT NO	APPLICATION	PRIMARY VOLTAGE	SECONDARY VOLTAGE	CIRCUIT BREAKERS	MAX LOAD	CIRCUIT CAPACITY
ADNM Series Class 2 Transformer	ADNM-120-1-4-24-DTV	Indoor / Outdoor	100-277V AC 5ø60 Hz	24V DC	1	1x96W	1x4A
	ADNM-240-2-4-24-DTV				2	2x96W	2x4A
	ADNM-320-3-4-24-DTV				3	3x96W	3x4A

Power Supplies - Outdoor

INFINITY - MLV / ELV / 0-10V / PWM / TRIAC

DESCRIPTION	CAT NO	APPLICATION	PRIMARY VOLTAGE	SECONDARY VOLTAGE	CIRCUIT BREAKERS	MAX LOAD	MIN LOAD	CIRCUIT CAPACITY
Infinity Series Class 2 Transformer	INF-J-30-1-1.3-24	Indoor / Outdoor	100 - 277V AC	24VDC	1	30W	3W	1.3A
	INF-J-60-1-2.5-24				1	60W	6W	2.5A
	INF-J-96-1-4-24				1	96W	9W	4A
	INF-J-192-2-4-24				2	2x96W	2x9W	2x4A
	INF-J-288-3-4-24				3	3x96W	3x9W	3x4A

Dimmers

DIMMING - 0-10V

DESCRIPTION	CAT NO	APPLICATION	INPUT VOLTAGE	OUTPUT VOLTAGE	MAX LOAD
0-10V Dimmer	DIM-LD-010	Indoor	24V DC	24V DC	30 mA max. output (sink only)

DIMMING - MLV

DESCRIPTION	CAT NO	APPLICATION	INPUT VOLTAGE	OUTPUT VOLTAGE	MAX LOAD
MLV Dimmer	N-600	Indoor	120V AC	120V AC	450W
	N-1000				800W
	N-1500				1200W
	D-600				450W
	M-600				450W
	M-1000				800W

DIMMING - ELV

DESCRIPTION	CAT NO	APPLICATION	INPUT VOLTAGE	OUTPUT VOLTAGE	MAX LOAD
ELV Dimmer	ME-600	Indoor	120V AC	120V AC	450W
	DE-300				300W